

SIT timing pulleys - SUPER TORQUE STPD

STPD pulleys have a different design from the traditional toothed pulleys.

The bottom of the pulley grooves is convex-shaped and the depth of the grooves is smaller than the height of the belt tooth, thus ensuring the effect of "interference" drastically reducing the polygonal effect.

The axial grooves are designed to allow the belt teeth to catch the pulley teeth with negligible friction.

STPD pulleys are available with solid hub and for assembly with SER-SIT® taper bushing

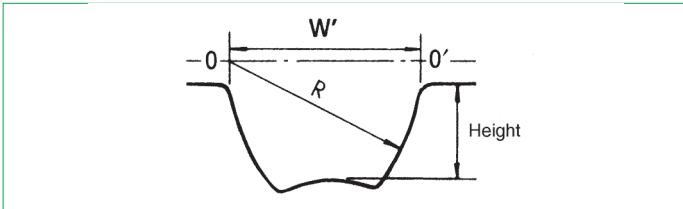

Solid hub

Material: cast iron/steel

Finishing: black manganese phosphating

Pitch:

- S3M
- S4,5M
- S5M
- S8M
- S14M



For mounting taper bushing SER-SIT®

Material: cast iron

Finishing: black manganese phosphating

Pitch:

- S8M
- S14M



Special executions

Upon request, SIT is able to design and manufacture any type of pulley based on customer requirements.

For peripheral speed exceeding 33 m/s it is strongly recommended to use steel as material of construction.

$$\text{peripheral speed [m/s]} = \frac{\text{pulley diameter [mm]} \cdot \text{rpm}}{19100}$$

In order to reduce the system weight, the pulleys can be manufactured from light metals; in this case the lifetime will be reduced when compared to the standard because the nylon belt coating has a slightly abrasive effect. This disadvantage can be reduced with a high thickness anodization coating of the teeth

TOLERANCES

Pulley diameter tolerances

External diameter [mm]	Tolerances [mm]
up to 25,4	-0,00 +0,05
from 25,5 to 50,8	-0,00 +0,08
from 50,9 to 101,6	-0,00 +0,10
from 101,7 to 177,8	-0,00 +0,13
from 177,9 to 304,8	-0,00 +0,15
from 304,9 to 508,0	-0,00 +0,18
more than 508,1	-0,00 +0,25

Radial circular runout

External diameter [mm]	Measured total eccentricity [mm]
up to 200	0,13
more than 200	add 0,0005 for any mm more than 200

Cylindricity tolerance

Pulley width	Tolerance
for any 100 mm	0,1 mm without exceeding the external diameter tolerance

Flanged pulleys

Timing belts, when in motion, have a slight lateral displacement. It is therefore necessary to use at least one flanged pulley to prevent the belt jumping out of the pulley.

Usually, in order to reduce the costs, the flanged pulley is the one with the smaller diameter.

In any case, when the distance of the axes is greater than 8 times the diameter of the small pulley, or when the transmission is working on shafts arranged in a position that is not horizontal one, both pulleys have to be flanged.

Protective coating

All (steel and cast iron) pulleys are treated with a black manganese phosphating process that gives greater resistance against oxidizing agents. This treatment does not modify the profile or the dimensions of the pulleys.

On request SIT can provide a wide range of special coating, related to the customer specific needs or environmental critical conditions.

Note

Due to a constant improvement of our products, technical data of the pulleys may be subject to changes.

Dimensions of timing pulleys SUPER TORQUE - solid hub pitches 8M - 14M



Part Number	ST 48 S 8M 20
SUPERTORQUE timing pulleys - solid hub	
Number of teeth	
Pitch	
Belt width in mm	

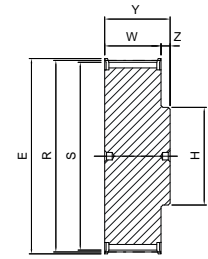

1

ST ... S8M20

8M

Code	Teeth nr.	Type	E [mm]	R [mm]	S [mm]	U [mm]	H [mm]	d [mm]	W [mm]	Y [mm]	Z [mm]	Flange	Material
ST18S8M20	18	1	50,0	45,84	44,46	-	32,0	-	28,0	38,0	10,0	with flanges	steel
ST20S8M20	20	1	55,0	50,93	49,56	-	36,0	-	28,0	38,0	10,0		
ST22S8M20	22	1	62,0	56,02	54,65	-	43,0	-	28,0	38,0	10,0		
ST24S8M20	24	1	67,0	61,12	59,74	-	49,0	-	28,0	38,0	10,0		
ST26S8M20	26	1	73,0	66,21	64,84	-	50,0	-	28,0	38,0	10,0		
ST28S8M20	28	1	77,0	71,30	69,93	-	55,0	-	28,0	38,0	10,0		
ST30S8M20	30	1	84,0	76,39	75,02	-	60,0	-	28,0	38,0	10,0		
ST32S8M20	32	1	88,0	81,49	80,12	-	64,0	-	28,0	38,0	10,0		
ST34S8M20	34	1	94,0	86,58	85,21	-	70,0	-	28,0	38,0	10,0		
ST36S8M20	36	1	98,0	91,67	90,30	-	75,0	-	28,0	38,0	10,0		
ST38S8M20	38	1	104,0	96,77	95,39	-	80,0	-	28,0	38,0	10,0		
ST40S8M20	40	1	108,0	101,86	100,49	-	85,0	-	28,0	38,0	10,0		
ST44S8M20	44	1	121,0	112,05	110,67	-	96,0	-	28,0	38,0	10,0		
ST48S8M20	48	1	129,0	122,23	120,86	-	104,0	-	28,0	38,0	10,0		
ST56S8M20	56	3	149,0	142,60	141,23	117,0	80,0	-	28,0	38,0	10,0	without flanges	cast iron
ST60S8M20	60	3	158,0	152,79	151,42	127,0	80,0	-	28,0	38,0	10,0		
ST64S8M20	64	3	168,0	162,97	161,60	137,0	80,0	-	28,0	38,0	10,0		
ST72S8M20	72	3	191,0	183,35	181,97	158,0	80,0	-	28,0	38,0	10,0		
ST80S8M20	80	3A	-	203,72	202,35	179,0	90,0	-	28,0	38,0	10,0		
ST84S8M20	84	3A	-	213,90	212,53	190,0	90,0	-	28,0	38,0	10,0		
ST90S8M20	90	3A	-	229,18	227,81	204,0	90,0	-	28,0	38,0	10,0		
ST112S8M20	112	5B	-	285,21	283,83	260,0	90,0	19,0	28,0	38,0	10,0		
ST144S8M20	144	5B	-	366,69	365,32	342,0	90,0	19,0	28,0	38,0	10,0		
ST168S8M20	168	5B	-	427,80	426,42	403,0	100,0	19,0	28,0	38,0	10,0		
ST192S8M20	192	5B	-	488,92	487,54	465,0	100,0	19,0	28,0	38,0	10,0		

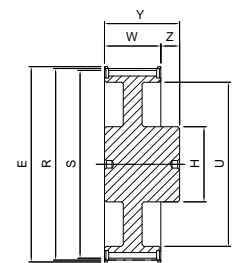

3

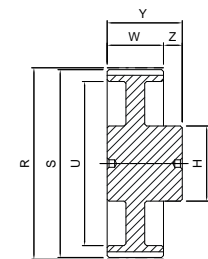

3A

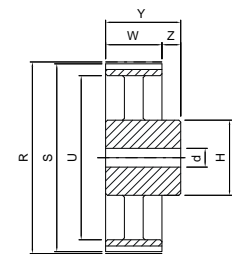

5B

Dimensions of timing pulleys SUPER TORQUE - solid hub



ST ... S8M30

8M

Code	Teeth nr.	Type	E [mm]	R [mm]	S [mm]	U [mm]	H [mm]	d [mm]	W [mm]	Y [mm]	Z [mm]	Flange	Material
ST18S8M30	18	1	50,0	45,84	44,46	-	32,0	-	38,0	48,0	10,0	with flanges	steel
ST20S8M30	20	1	55,0	50,93	49,56	-	36,0	-	38,0	48,0	10,0		
ST22S8M30	22	1	62,0	56,02	54,65	-	43,0	-	38,0	48,0	10,0		
ST24S8M30	24	1	67,0	61,12	59,74	-	49,0	-	38,0	48,0	10,0		
ST26S8M30	26	1	73,0	66,21	64,84	-	50,0	-	38,0	48,0	10,0		
ST28S8M30	28	1	77,0	71,30	69,93	-	55,0	-	38,0	48,0	10,0		
ST30S8M30	30	1	84,0	76,39	75,02	-	60,0	-	38,0	48,0	10,0		
ST32S8M30	32	1	88,0	81,49	80,12	-	64,0	-	38,0	48,0	10,0		
ST34S8M30	34	1	94,0	86,58	85,21	-	70,0	-	38,0	48,0	10,0		
ST36S8M30	36	1	98,0	91,67	90,30	-	75,0	-	38,0	48,0	10,0		
ST38S8M30	38	1	104,0	96,77	95,39	-	80,0	-	38,0	48,0	10,0		
ST40S8M30	40	1	108,0	101,86	100,49	-	85,0	-	38,0	48,0	10,0		
ST44S8M30	44	1	121,0	112,05	110,67	-	96,0	-	38,0	48,0	10,0		
ST48S8M30	48	1	129,0	122,23	120,86	-	104,0	-	38,0	48,0	10,0		
ST56S8M30	56	3	149,0	142,60	141,23	117,0	90,0	-	38,0	48,0	10,0		
ST60S8M30	60	3	158,0	152,79	151,42	127,0	90,0	-	38,0	48,0	10,0		
ST64S8M30	64	3	168,0	162,97	161,60	137,0	90,0	-	38,0	48,0	10,0		
ST72S8M30	72	3	191,0	183,35	181,97	158,0	95,0	-	38,0	48,0	10,0		
ST80S8M30	80	3A	-	203,72	202,35	179,0	100,0	-	38,0	48,0	10,0		
ST84S8M30	84	3A	-	213,90	212,53	190,0	100,0	-	38,0	48,0	10,0		
ST90S8M30	90	3A	-	229,18	227,81	204,0	100,0	-	38,0	48,0	10,0		
ST112S8M30	112	5B	-	285,21	283,83	260,0	100,0	19,0	38,0	48,0	10,0		
ST144S8M30	144	5B	-	366,69	365,32	342,0	100,0	19,0	38,0	48,0	10,0		
ST168S8M30	168	5B	-	427,80	426,42	403,0	100,0	19,0	38,0	48,0	10,0		
ST192S8M30	192	5B	-	488,92	487,54	465,0	100,0	19,0	38,0	48,0	10,0		

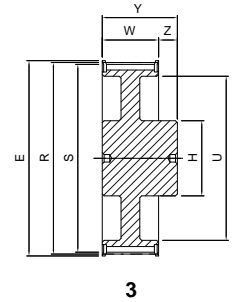
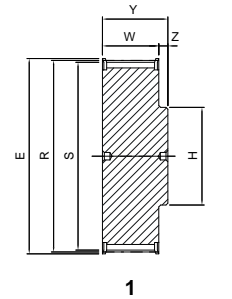

ST ... S8M50

8M

Code	Teeth nr.	Type	E [mm]	R [mm]	S [mm]	U [mm]	H [mm]	d [mm]	W [mm]	Y [mm]	Z [mm]	Flange	Material
ST18S8M50	18	1	50,0	45,84	44,46	-	32,0	-	60,0	70,0	10,0	with flanges	steel
ST20S8M50	20	1	55,0	50,93	49,56	-	36,0	-	60,0	70,0	10,0		
ST22S8M50	22	1	62,0	56,02	54,65	-	43,0	-	60,0	70,0	10,0		
ST24S8M50	24	1	67,0	61,12	59,74	-	49,0	-	60,0	70,0	10,0		
ST26S8M50	26	1	73,0	66,21	64,84	-	50,0	-	60,0	70,0	10,0		
ST28S8M50	28	1	77,0	71,30	69,93	-	55,0	-	60,0	70,0	10,0		
ST30S8M50	30	1	84,0	76,39	75,02	-	60,0	-	60,0	70,0	10,0		
ST32S8M50	32	1	88,0	81,49	80,12	-	64,0	-	60,0	70,0	10,0		
ST34S8M50	34	1	94,0	86,58	85,21	-	70,0	-	60,0	70,0	10,0		
ST36S8M50	36	1	98,0	91,67	90,30	-	75,0	-	60,0	70,0	10,0		
ST38S8M50	38	1	104,0	96,77	95,39	-	80,0	-	60,0	70,0	10,0		
ST40S8M50	40	1	108,0	101,86	100,49	-	85,0	-	60,0	70,0	10,0		
ST44S8M50	44	1	121,0	112,05	110,67	-	96,0	-	60,0	70,0	10,0		
ST48S8M50	48	1	129,0	122,23	120,86	-	104,0	-	60,0	70,0	10,0		
ST56S8M50	56	6	149,0	142,60	141,23	117,0	90,0	-	60,0	60,0	-		
ST60S8M50	60	6	158,0	152,79	151,42	127,0	100,0	-	60,0	60,0	-		
ST64S8M50	64	6	168,0	162,97	161,60	137,0	100,0	-	60,0	60,0	-		
ST72S8M50	72	6	191,0	183,35	181,97	158,0	100,0	-	60,0	60,0	-		
ST80S8M50	80	6A	-	203,72	202,35	179,0	110,0	-	60,0	60,0	-		
ST84S8M50	84	6A	-	213,90	212,53	190,0	110,0	-	60,0	60,0	-		
ST90S8M50	90	6A	-	229,18	227,81	204,0	110,0	-	60,0	60,0	-		
ST112S8M50	112	7B	-	285,21	283,83	260,0	110,0	19,0	60,0	60,0	-		
ST144S8M50	144	7B	-	366,69	365,32	342,0	110,0	19,0	60,0	60,0	-		
ST168S8M50	168	7B	-	427,80	426,42	403,0	120,0	19,0	60,0	60,0	-		
ST192S8M50	192	7B	-	488,92	487,54	465,0	130,0	19,0	60,0	60,0	-		

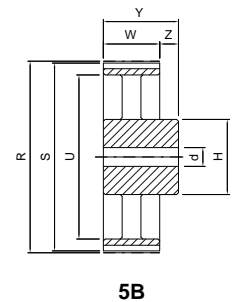
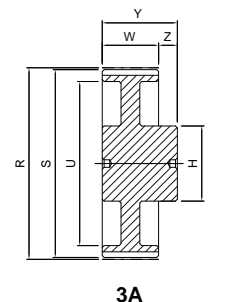

Dimensions of timing pulleys SUPER TORQUE - solid hub



ST ... S8M85

8M

Code	Teeth nr.	Type	E [mm]	R [mm]	S [mm]	U [mm]	H [mm]	d [mm]	W [mm]	Y [mm]	Z [mm]	Flange	Material
ST22S8M85	22	1	62,0	56,02	54,65	-	43,0	-	95,0	105,0	10,0	with flanges	steel
ST24S8M85	24	1	67,0	61,12	59,74	-	49,0	-	95,0	105,0	10,0		
ST26S8M85	26	1	73,0	66,21	64,84	-	50,0	-	95,0	105,0	10,0		
ST28S8M85	28	1	77,0	71,30	69,93	-	55,0	-	95,0	105,0	10,0		
ST30S8M85	30	1	84,0	76,39	75,02	-	60,0	-	95,0	105,0	10,0		
ST32S8M85	32	1	88,0	81,49	80,12	-	64,0	-	95,0	105,0	10,0		
ST34S8M85	34	1	94,0	86,58	85,21	-	70,0	-	95,0	105,0	10,0		
ST36S8M85	36	1	98,0	91,67	90,30	-	75,0	-	95,0	105,0	10,0		
ST38S8M85	38	1	104,0	96,77	95,39	-	80,0	-	95,0	105,0	10,0		
ST40S8M85	40	1	108,0	101,86	100,49	-	85,0	-	95,0	105,0	10,0		
ST44S8M85	44	1	121,0	112,05	110,67	-	96,0	-	95,0	105,0	10,0		
ST48S8M85	48	1	129,0	122,23	120,86	-	104,0	-	95,0	105,0	10,0		
ST56S8M85	56	1	149,0	142,60	141,23	-	107,0	-	95,0	105,0	10,0		
ST60S8M85	60	1	158,0	152,79	151,42	-	132,0	-	95,0	105,0	10,0		
ST64S8M85	64	6	168,0	162,97	161,60	137,0	100,0	-	95,0	95,0	-		
ST72S8M85	72	6	191,0	183,35	181,97	158,0	110,0	-	95,0	95,0	-		
ST80S8M85	80	6A	-	203,72	202,35	179,0	110,0	-	95,0	95,0	-		
ST84S8M85	84	6A	-	213,90	212,53	190,0	110,0	-	95,0	95,0	-		
ST90S8M85	90	6B	-	229,18	227,81	204,0	110,0	-	95,0	95,0	-		
ST112S8M85	112	7B	-	285,21	283,83	260,0	110,0	19,0	95,0	95,0	-		
ST144S8M85	144	7B	-	366,69	365,32	342,0	120,0	19,0	95,0	95,0	-		
ST168S8M85	168	7B	-	427,80	426,42	403,0	120,0	19,0	95,0	95,0	-		
ST192S8M85	192	7B	-	488,92	487,54	465,0	130,0	19,0	95,0	95,0	-		

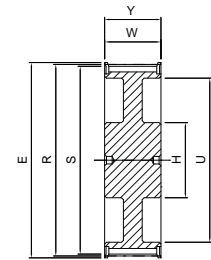

6

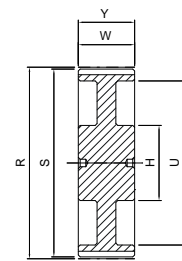

6A

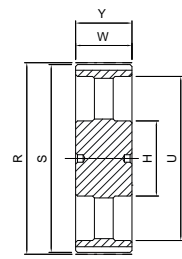

6B

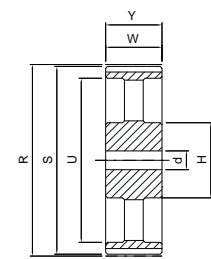

7B

ST ... S14M40

14M

Code	Teeth nr.	Type	E [mm]	R [mm]	S [mm]	U [mm]	H [mm]	d [mm]	W [mm]	Y [mm]	Z [mm]	Flange	Material
ST28S14M40	28	1	134,0	124,78	121,98	-	100,0	-	54,0	69,0	15,0	with flanges	cast iron
ST29S14M40	29	1	134,0	129,23	126,44	-	107,0	-	54,0	69,0	15,0		
ST30S14M40	30	1	142,0	133,69	130,90	-	107,0	-	54,0	69,0	15,0		
ST32S14M40	32	1	150,0	142,60	139,81	-	114,0	-	54,0	69,0	15,0		
ST34S14M40	34	1	158,0	151,51	148,72	-	122,0	-	54,0	69,0	15,0		
ST36S14M40	36	1	166,0	160,43	157,63	-	128,0	-	54,0	69,0	15,0		
ST38S14M40	38	1	177,0	169,34	166,55	-	141,0	-	54,0	69,0	15,0		
ST40S14M40	40	1	186,0	178,25	175,46	-	148,0	-	54,0	69,0	15,0		
ST44S14M40	44	3	209,0	196,08	193,28	154,0	120,0	-	54,0	69,0	15,0		
ST48S14M40	48	3	216,0	213,90	211,11	172,0	135,0	-	54,0	69,0	15,0		
ST56S14M40	56	3	261,0	249,56	246,76	207,0	135,0	-	54,0	69,0	15,0		
ST60S14M40	60	3	274,0	267,38	264,59	225,0	135,0	-	54,0	69,0	15,0		
ST64S14M40	64	3	288,0	285,21	282,41	243,0	135,0	-	54,0	69,0	15,0		
ST72S14M40	72	5B	-	320,86	318,06	279,0	135,0	19,0	54,0	69,0	15,0		
ST80S14M40	80	5B	-	356,51	353,71	314,0	135,0	19,0	54,0	69,0	15,0		
ST84S14M40	84	5B	-	374,33	371,54	332,0	135,0	19,0	54,0	69,0	15,0		
ST90S14M40	90	5B	-	401,07	398,28	359,0	135,0	19,0	54,0	69,0	15,0		
ST112S14M40	112	5B	-	499,11	496,32	457,0	135,0	19,0	54,0	69,0	15,0		
ST144S14M40	144	5B	-	641,71	638,92	600,0	135,0	19,0	54,0	69,0	15,0		

Dimensions of timing pulleys SUPER TORQUE - solid hub



ST ... S14M55

14M

Code	Teeth nr.	Type	E [mm]	R [mm]	S [mm]	U [mm]	H [mm]	d [mm]	W [mm]	Y [mm]	Z [mm]	Flange	Material
ST28S14M55	28	1	134,0	124,78	121,98	-	100,0	-	70,0	85,0	15,0	with flanges	cast iron
ST29S14M55	29	1	134,0	129,23	126,44	-	107,0	-	70,0	85,0	15,0		
ST30S14M55	30	1	142,0	133,69	130,90	-	107,0	-	70,0	85,0	15,0		
ST32S14M55	32	1	150,0	142,60	139,81	-	114,0	-	70,0	85,0	15,0		
ST34S14M55	34	1	158,0	151,51	148,72	-	122,0	-	70,0	85,0	15,0		
ST36S14M55	36	1	166,0	160,43	157,63	-	128,0	-	70,0	85,0	15,0		
ST38S14M55	38	1	177,0	169,34	166,55	-	141,0	-	70,0	85,0	15,0		
ST40S14M55	40	1	186,0	178,25	175,46	-	148,0	-	70,0	85,0	15,0		
ST44S14M55	44	3	209,0	196,08	193,28	154,0	120,0	-	70,0	85,0	15,0		
ST48S14M55	48	6	216,0	213,90	211,11	172,0	135,0	-	70,0	70,0	-		
ST56S14M55	56	6	261,0	249,56	246,76	207,0	135,0	-	70,0	70,0	-		
ST60S14M55	60	6	274,0	267,38	264,59	225,0	135,0	-	70,0	70,0	-		
ST64S14M55	64	6	288,0	285,21	282,41	243,0	135,0	-	70,0	70,0	-		
ST72S14M55	72	7B	-	320,86	318,06	279,0	135,0	19,0	70,0	70,0	-		
ST80S14M55	80	7B	-	356,51	353,71	314,0	135,0	19,0	70,0	70,0	-		
ST84S14M55	84	7B	-	374,33	371,54	332,0	135,0	19,0	70,0	70,0	-		
ST90S14M55	90	7B	-	401,07	398,28	359,0	135,0	19,0	70,0	70,0	-		
ST112S14M55	112	7B	-	499,11	496,32	457,0	135,0	19,0	70,0	70,0	-		
ST144S14M55	144	7B	-	641,71	638,92	600,0	135,0	19,0	70,0	70,0	-		

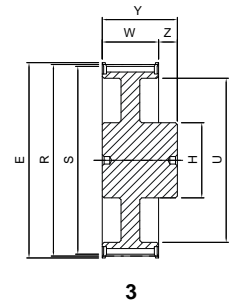
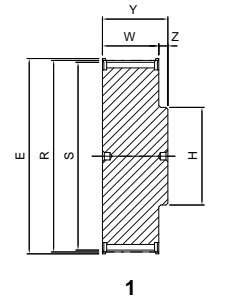

ST ... S14M85

14M

Code	Teeth nr.	Type	E [mm]	R [mm]	S [mm]	U [mm]	H [mm]	d [mm]	W [mm]	Y [mm]	Z [mm]	Flange	Material
ST28S14M85	28	1	134,0	124,78	121,98	-	100,0	-	102,0	117,0	15,0	with flanges	cast iron
ST29S14M85	29	1	134,0	129,23	126,44	-	107,0	-	102,0	117,0	15,0		
ST30S14M85	30	1	142,0	133,69	130,90	-	107,0	-	102,0	117,0	15,0		
ST32S14M85	32	1	150,0	142,60	139,81	-	114,0	-	102,0	117,0	15,0		
ST34S14M85	34	1	158,0	151,51	148,72	-	122,0	-	102,0	117,0	15,0		
ST36S14M85	36	1	166,0	160,43	157,63	-	128,0	-	102,0	117,0	15,0		
ST38S14M85	38	1	177,0	169,34	166,55	-	141,0	-	102,0	117,0	15,0		
ST40S14M85	40	1	186,0	178,25	175,46	-	148,0	-	102,0	117,0	15,0		
ST44S14M85	44	1	209,0	196,08	193,28	-	169,0	-	102,0	117,0	15,0		
ST48S14M85	48	1	216,0	213,90	211,11	-	186,0	-	102,0	117,0	15,0		
ST56S14M85	56	6	261,0	249,56	246,76	207,0	150,0	-	102,0	102,0	-		
ST60S14M85	60	6	274,0	267,38	264,59	225,0	150,0	-	102,0	102,0	-		
ST64S14M85	64	6	288,0	285,21	282,41	243,0	150,0	-	102,0	102,0	-		
ST72S14M85	72	7B	-	320,86	318,06	279,0	150,0	19,0	102,0	102,0	-		
ST80S14M85	80	7B	-	356,51	353,71	314,0	150,0	19,0	102,0	102,0	-		
ST84S14M85	84	7B	-	374,33	371,54	332,0	150,0	19,0	102,0	102,0	-		
ST90S14M85	90	7B	-	401,07	398,28	359,0	150,0	19,0	102,0	102,0	-		
ST112S14M85	112	7B	-	499,11	496,32	457,0	150,0	19,0	102,0	102,0	-		
ST144S14M85	144	7B	-	641,71	638,92	600,0	150,0	19,0	102,0	102,0	-		

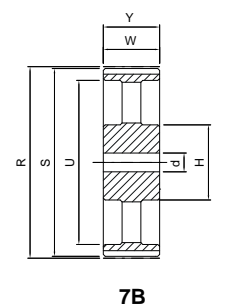
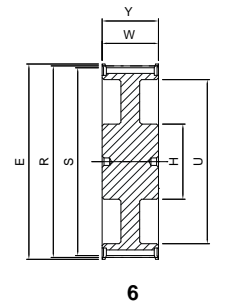

Dimensions of timing pulleys SUPER TORQUE - solid hub



ST ... S14M115

14M

Code	Teeth nr.	Type	E [mm]	R [mm]	S [mm]	U [mm]	H [mm]	d [mm]	W [mm]	Y [mm]	Z [mm]	Flange	Material	
ST28S14M115	28	1	134,0	124,78	121,98	-	100,0	-	133,0	148,0	15,0	with flanges	cast iron	
ST29S14M115	29	1	134,0	129,23	126,44	-	107,0	-	133,0	148,0	15,0			
ST30S14M115	30	1	142,0	133,69	130,90	-	107,0	-	133,0	148,0	15,0			
ST32S14M115	32	1	150,0	142,60	139,81	-	114,0	-	133,0	148,0	15,0			
ST34S14M115	34	1	158,0	151,51	148,72	-	122,0	-	133,0	148,0	15,0			
ST36S14M115	36	1	166,0	160,43	157,63	-	128,0	-	133,0	148,0	15,0			
ST38S14M115	38	1	177,0	169,34	166,55	-	141,0	-	133,0	148,0	15,0			
ST40S14M115	40	1	186,0	178,25	175,46	-	148,0	-	133,0	148,0	15,0			
ST44S14M115	44	1	209,0	196,08	193,28	-	169,0	-	133,0	148,0	15,0			
ST48S14M115	48	1	216,0	213,90	211,11	-	186,0	-	133,0	148,0	15,0			
ST56S14M115	56	3	261,0	249,56	246,76	207,0	150,0	-	133,0	133,0	-			
ST60S14M115	60	6	274,0	267,38	264,59	225,0	150,0	-	133,0	133,0	-			
ST64S14M115	64	6	288,0	285,21	282,41	243,0	150,0	-	133,0	133,0	-			
ST72S14M115	72	7B	-	320,86	318,06	279,0	150,0	19,0	133,0	133,0	-			
ST80S14M115	80	7B	-	356,51	353,71	314,0	150,0	19,0	133,0	133,0	-			
ST84S14M115	84	7B	-	374,33	371,54	332,0	150,0	19,0	133,0	133,0	-			
ST90S14M115	90	7B	-	401,07	398,28	359,0	150,0	19,0	133,0	133,0	-			
ST112S14M115	112	7B	-	499,11	496,32	457,0	150,0	19,0	133,0	133,0	-			
ST144S14M115	144	7B	-	641,71	638,92	600,0	150,0	19,0	133,0	133,0	-			
												without flanges		

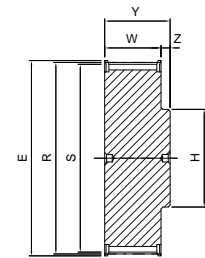

1

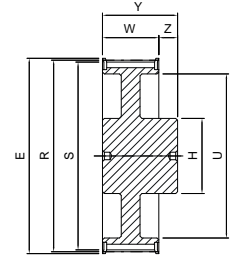

3

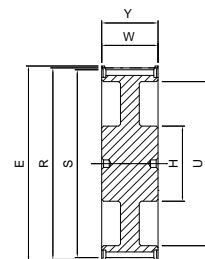

6

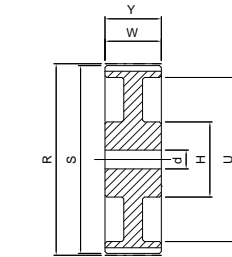

7A

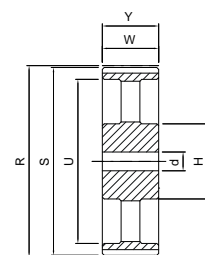

7B

ST ... S14M170

14M

Code	Teeth nr.	Type	E [mm]	R [mm]	S [mm]	U [mm]	H [mm]	d [mm]	W [mm]	Y [mm]	Z [mm]	Flange	Material	
ST28S14M170	28	1	134,0	124,78	121,98	-	100,0	-	187,0	202,0	15,0	with flanges	cast iron	
ST29S14M170	29	1	134,0	129,23	126,44	-	107,0	-	187,0	202,0	15,0			
ST30S14M170	30	1	142,0	133,69	130,90	-	107,0	-	187,0	202,0	15,0			
ST32S14M170	32	1	150,0	142,60	139,81	-	114,0	-	187,0	202,0	15,0			
ST34S14M170	34	1	158,0	151,51	148,72	-	122,0	-	187,0	202,0	15,0			
ST36S14M170	36	1	166,0	160,43	157,63	-	128,0	-	187,0	202,0	15,0			
ST38S14M170	38	1	177,0	169,34	166,55	-	141,0	-	187,0	202,0	15,0			
ST40S14M170	40	1	186,0	178,25	175,46	-	148,0	-	187,0	202,0	15,0			
ST44S14M170	44	1	209,0	196,08	193,28	-	169,0	-	187,0	202,0	15,0			
ST48S14M170	48	1	216,0	213,90	211,11	-	186,0	-	187,0	202,0	15,0			
ST56S14M170	56	3	261,0	249,56	246,76	207,0	160,0	-	187,0	202,0	15,0			
ST60S14M170	60	3	274,0	267,38	264,59	225,0	160,0	-	187,0	202,0	15,0			
ST64S14M170	64	3	288,0	285,21	282,41	243,0	180,0	-	187,0	202,0	15,0			
ST72S14M170	72	7A	-	320,86	318,06	279,0	180,0	19,0	187,0	187,0	-			
ST80S14M170	80	7A	-	356,51	353,71	314,0	180,0	19,0	187,0	187,0	-			
ST84S14M170	84	7B	-	374,33	371,54	332,0	180,0	19,0	187,0	187,0	-			
ST90S14M170	90	7B	-	401,07	398,28	359,0	180,0	19,0	187,0	187,0	-			
ST112S14M170	112	7B	-	499,11	496,32	457,0	200,0	19,0	187,0	187,0	-			
ST144S14M170	144	7B	-	641,71	638,92	600,0	220,0	19,0	187,0	187,0	-			
												without flanges		

Dimensions of timing pulleys SUPER TORQUE - mounting taper bushing SER-SIT® itches 8M - 14M



Part Number **STB 32 S 8M 20**

SUPER TORQUE pulley - mounting taper bushing

Number of teeth

Pitch

Belt width in mm

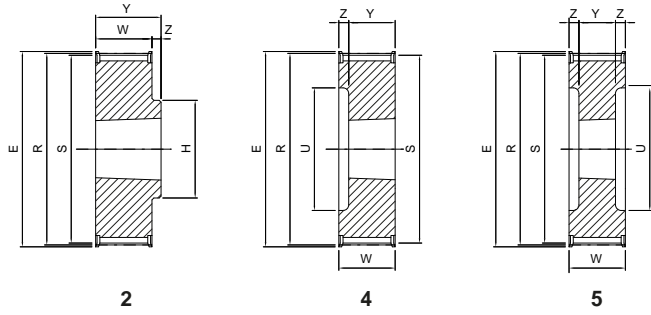

STB ... S8M 20

Code	Teeth nr.	Type	SER-SIT® Taper bushing	E [mm]	R [mm]	S [mm]	U [mm]	H [mm]	W [mm]	Y [mm]	Z [mm]	Flange	Material
STB22S8M20	22	4	1008	62,0	56,02	54,65	38,0	-	28,0	22,0	6,0	with flanges	cast iron
STB24S8M20	24	4	1108	67,0	61,12	59,74	42,0	-	28,0	22,0	6,0		
STB26S8M20	26	4	1108	73,0	66,21	64,84	45,0	-	28,0	22,0	6,0		
STB28S8M20	28	4	1108	77,0	71,30	69,93	52,0	-	28,0	22,0	6,0		
STB30S8M20	30	4	1108	84,0	76,39	75,02	56,0	-	28,0	22,0	6,0		
STB32S8M20	32	4	1610	88,0	81,49	80,12	65,0	-	28,0	25,0	3,0		
STB34S8M20	34	4	1610	94,0	86,58	85,21	66,0	-	28,0	25,0	3,0		
STB36S8M20	36	4	1610	98,0	91,67	90,30	68,0	-	28,0	25,0	3,0		
STB38S8M20	38	4	1610	104,0	96,77	95,39	76,0	-	28,0	25,0	3,0		
STB40S8M20	40	4	1610	108,0	101,86	100,49	80,0	-	28,0	25,0	3,0		
STB44S8M20	44	2	2012	121,0	112,05	110,67	-	99,0	28,0	32,0	4,0		
STB48S8M20	48	2	2012	129,0	122,23	120,86	-	105,0	28,0	32,0	4,0		
STB56S8M20	56	2	2012	149,0	142,60	141,23	-	105,0	28,0	32,0	4,0		
STB64S8M20	64	9	2012	168,0	162,97	161,60	140,0	110,0	28,0	32,0	4,0		
STB72S8M20	72	9	2012	191,0	183,35	181,97	158,0	110,0	28,0	32,0	4,0		
STB80S8M20	80	9A	2012	-	203,72	202,35	178,0	110,0	28,0	32,0	4,0		
STB90S8M20	90	9B	2012	-	229,18	227,81	204,0	110,0	28,0	32,0	4,0		
												without flanges	

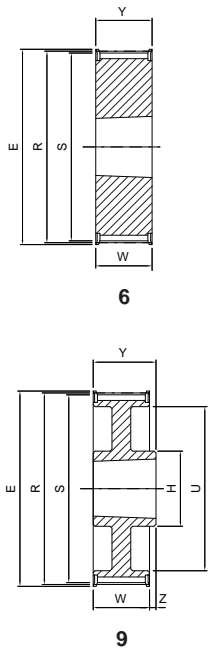

STB ... S8M 30

Code	Teeth nr.	Type	SER-SIT® Taper bushing	E [mm]	R [mm]	S [mm]	U [mm]	H [mm]	W [mm]	Y [mm]	Z [mm]	Flange	Material
STB22S8M30	22	4	1008	62,0	56,02	54,65	38,0	-	38,0	22,0	16,0	with flanges	cast iron
STB24S8M30	24	4	1108	67,0	61,12	59,74	42,0	-	38,0	22,0	16,0		
STB26S8M30	26	4	1108	73,0	66,21	64,84	45,0	-	38,0	22,0	16,0		
STB28S8M30	28	4	1108	77,0	71,30	69,93	52,0	-	38,0	22,0	16,0		
STB30S8M30	30	6	1615	84,0	76,39	75,02	-	-	38,0	38,0	-		
STB32S8M30	32	6	1615	88,0	81,49	80,12	-	-	38,0	38,0	-		
STB34S8M30	34	6	1615	94,0	86,58	85,21	-	-	38,0	38,0	-		
STB36S8M30	36	6	1615	98,0	91,67	90,30	-	-	38,0	38,0	-		
STB38S8M30	38	6	1615	104,0	96,77	95,39	-	-	38,0	38,0	-		
STB40S8M30	40	6	1615	108,0	101,86	100,49	-	-	38,0	38,0	-		
STB44S8M30	44	5	2012	121,0	112,05	110,67	90,0	-	38,0	32,0	-		
STB48S8M30	48	5	2012	129,0	122,23	120,86	98,0	-	38,0	32,0	3,0		
STB56S8M30	56	5	2012	149,0	142,60	141,23	118,0	-	38,0	32,0	3,0		
STB64S8M30	64	9	2517	168,0	162,97	161,6	140,0	120,0	38,0	45,0	3,0		
STB72S8M30	72	9	2517	191,0	183,35	181,97	158,0	120,0	38,0	45,0	7,0		
STB80S8M30	80	9A	2517	-	203,72	202,35	178,0	120,0	38,0	45,0	7,0		
STB90S8M30	90	9B	2517	-	229,18	227,81	204,0	120,0	38,0	45,0	7,0		
STB112S8M30	112	9B	2517	-	285,21	283,83	260,0	120,0	38,0	45,0	7,0		
STB144S8M30	144	9B	2517	-	366,69	365,32	341,0	120,0	38,0	45,0	7,0		
												without flanges	

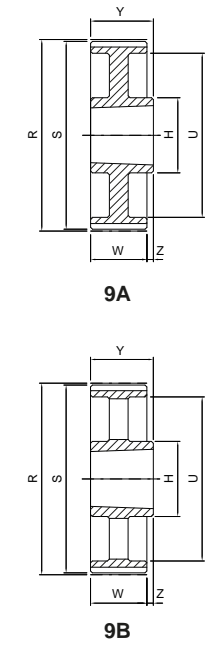

Dimensions of timing pulleys SUPER TORQUE - mounting taper bushing SER-SIT®

STB ... S8M 50

8M

Code	Teeth nr.	Type	SER-SIT® Taper bushing	E [mm]	R [mm]	S [mm]	U [mm]	H [mm]	W [mm]	Y [mm]	Z [mm]	Flange	Material	
STB28S8M50	28	5	1108	77,0	71,30	69,93	52,0	-	60,0	22,0	19,0	with flanges	cast iron	
STB30S8M50	30	4	1615	84,0	76,39	75,02	58,0	-	60,0	38,0	22,0			
STB32S8M50	32	4	1615	88,0	81,49	80,12	60,0	-	60,0	38,0	22,0			
STB34S8M50	34	4	1615	94,0	86,58	85,21	66,0	-	60,0	38,0	22,0			
STB36S8M50	36	4	1615	98,0	91,67	90,30	68,0	-	60,0	38,0	22,0			
STB38S8M50	38	4	1615	104,0	96,77	95,39	75,0	-	60,0	38,0	22,0			
STB40S8M50	40	5	2012	108,0	101,86	100,49	80,0	-	60,0	32,0	14,0			
STB44S8M50	44	5	2012	121,0	112,05	110,67	90,0	-	60,0	32,0	14,0			
STB48S8M50	48	5	2012	129,0	122,23	120,86	100,0	-	60,0	32,0	14,0			
STB56S8M50	56	5	2517	149,0	142,60	141,23	120,0	-	60,0	45,0	7,5			
STB64S8M50	64	8	2517	168,0	162,97	161,60	138,0	120,0	60,0	45,0	7,5			
STB72S8M50	72	8	2517	191,0	183,35	181,97	158,0	120,0	60,0	45,0	7,5			
STB80S8M50	80	8A	3020	-	203,72	202,35	178,0	160,0	60,0	51,0	4,5			
STB90S8M50	90	8A	3020	-	229,18	227,81	204,0	160,0	60,0	51,0	4,5			
STB112S8M50	112	8B	3020	-	285,21	283,83	260,0	160,0	60,0	51,0	4,5			
STB144S8M50	144	8B	3020	-	366,69	365,32	341,0	160,0	60,0	51,0	4,5			
STB168S8M50	168	8B	3020	-	427,80	426,42	402,0	160,0	60,0	51,0	4,5			
STB192S8M50	192	8B	3020	-	488,92	487,54	462,0	160,0	60,0	51,0	4,5			
												without flanges		

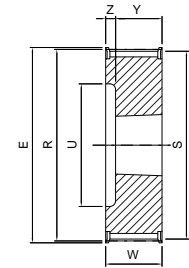
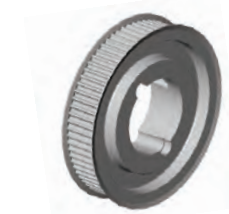

4

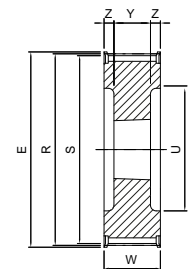

5

STB ... S8M 85

8M

Code	Teeth nr.	Type	SER-SIT® Taper bushing	E [mm]	R [mm]	S [mm]	U [mm]	H [mm]	W [mm]	Y [mm]	Z [mm]	Flange	Material	
STB34S8M85	34	5	1615	94,0	86,58	85,21	66,0	-	95,0	38,0	28,5	with flanges	cast iron	
STB36S8M85	36	5	1615	98,0	91,67	90,30	68,0	-	95,0	38,0	28,5			
STB38S8M85	38	5	1615	104,0	96,77	95,39	75,0	-	95,0	38,0	28,5			
STB40S8M85	40	5	2012	108,0	101,86	100,49	80,0	-	95,0	32,0	31,5			
STB44S8M85	44	5	2012	121,0	112,05	110,67	90,0	-	95,0	32,0	31,5			
STB48S8M85	48	5	2517	129,0	122,23	120,86	100,0	-	95,0	45,0	25,0			
STB56S8M85	56	5	2517	149,0	142,60	141,23	120,0	-	95,0	45,0	25,0			
STB64S8M85	64	5	2517	168,0	162,97	161,60	138,0	-	95,0	45,0	25,0			
STB72S8M85	72	5	3020	191,0	183,35	181,97	158,0	-	95,0	51,0	22,0			
STB80S8M85	80	8A	3020	-	203,72	202,35	178,0	160,0	95,0	51,0	22,0			
STB90S8M85	90	8A	3020	-	229,18	227,81	204,0	160,0	95,0	51,0	22,0			
STB112S8M85	112	8B	3020	-	285,21	283,83	260,0	160,0	95,0	51,0	22,0			
STB144S8M85	144	8B	3030	-	366,69	365,32	341,0	160,0	95,0	76,0	9,5			
STB168S8M85	168	8B	3030	-	427,80	426,42	402,0	160,0	95,0	76,0	9,5			
STB192S8M85	192	8B	3030	-	488,92	487,54	462,0	160,0	95,0	76,0	9,5			
												without flanges		

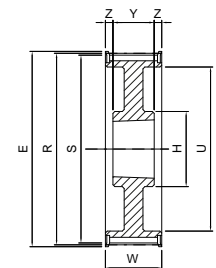

8

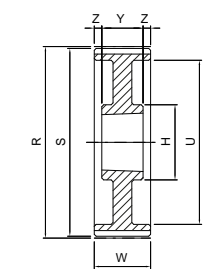

8A

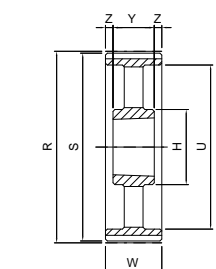

8B

TIMING PULLEYS - STB

Dimensions of timing pulleys SUPER TORQUE - mounting taper bushing SER-SIT®



STB ... S14M 40

14M

Code	Teeth nr.	Type	SER-SIT® Taper bushing	E [mm]	R [mm]	S [mm]	U [mm]	H [mm]	W [mm]	Y [mm]	Z [mm]	Flange	Material		
STB28S14M40	28	5	2012	134,0	124,78	121,98	98,0	-	54,0	32,0	11,0	with flanges	cast iron		
STB29S14M40	29	5	2012	134,0	129,23	126,44	100,0	-	54,0	32,0	11,0				
STB30S14M40	30	5	2012	142,0	133,69	130,90	100,0	-	54,0	32,0	11,0				
STB32S14M40	32	5	2012	150,0	142,60	139,81	104,0	-	54,0	32,0	11,0				
STB34S14M40	34	5	2517	158,0	151,51	148,72	110,0	-	54,0	45,0	4,5				
STB36S14M40	36	5	2517	166,0	160,43	157,63	120,0	-	54,0	45,0	4,5				
STB38S14M40	38	5	2517	177,0	169,34	166,55	130,0	-	54,0	45,0	4,5				
STB40S14M40	40	5	2517	186,0	178,25	175,46	138,0	-	54,0	45,0	4,5				
STB44S14M40	44	5	3020	209,0	196,08	193,28	154,0	-	54,0	51,0	1,5				
STB48S14M40	48	5	3020	216,0	213,90	211,11	172,0	-	54,0	51,0	1,5				
STB56S14M40	56	8	3020	261,0	249,56	246,76	207,0	160,0	54,0	51,0	1,5				
STB64S14M40	64	8	3020	288,0	285,21	282,41	243,0	160,0	54,0	51,0	1,5				
STB72S14M40	72	8A	3020	-	320,86	318,06	279,0	160,0	54,0	51,0	1,5			without flanges	cast iron
STB80S14M40	80	8B	3020	-	356,51	353,71	314,0	160,0	54,0	51,0	1,5				
STB90S14M40	90	8B	3020	-	401,07	398,28	359,0	160,0	54,0	51,0	1,5				
STB112S14M40	112	8B	3020	-	499,11	496,32	457,0	160,0	54,0	51,0	1,5				
STB144S14M40	144	8B	3020	-	641,71	638,92	600,0	160,0	54,0	51,0	1,5				

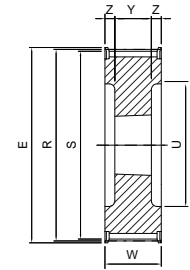

5

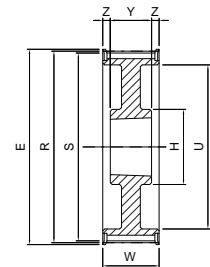

8

STB ... S14M 55

14M

Code	Teeth nr.	Type	SER-SIT® Taper bushing	E [mm]	R [mm]	S [mm]	U [mm]	H [mm]	W [mm]	Y [mm]	Z [mm]	Flange	Material		
STB28S14M55	28	5	2012	134,0	124,78	121,98	98,0	-	70,0	32,0	19,0	with flanges	cast iron		
STB29S14M55	29	5	2012	134,0	129,23	126,44	100,0	-	70,0	32,0	19,0				
STB30S14M55	30	5	2517	142,0	133,69	130,90	100,0	-	70,0	45,0	12,5				
STB32S14M55	32	5	2517	150,0	142,60	139,81	104,0	-	70,0	45,0	12,5				
STB34S14M55	34	5	2517	158,0	151,51	148,72	110,0	-	70,0	45,0	12,5				
STB36S14M55	36	5	2517	166,0	160,43	157,63	120,0	-	70,0	45,0	12,5				
STB38S14M55	38	5	2517	177,0	169,34	166,55	130,0	-	70,0	45,0	12,5				
STB40S14M55	40	5	2517	186,0	178,25	175,46	138,0	-	70,0	45,0	12,5				
STB44S14M55	44	5	3020	209,0	196,08	193,28	154,0	-	70,0	51,0	9,5				
STB48S14M55	48	5	3020	216,0	213,90	211,11	172,0	-	70,0	51,0	9,5				
STB56S14M55	56	8	3020	261,0	249,56	246,76	207,0	160,0	70,0	51,0	9,5				
STB64S14M55	64	8	3020	288,0	285,21	282,41	243,0	160,0	70,0	51,0	9,5				
STB72S14M55	72	8A	3020	-	320,86	318,06	279,0	160,0	70,0	51,0	9,5			without flanges	cast iron
STB80S14M55	80	8B	3020	-	356,51	353,71	314,0	160,0	70,0	51,0	9,5				
STB90S14M55	90	8B	3020	-	401,07	398,28	359,0	160,0	70,0	51,0	9,5				
STB112S14M55	112	8B	3020	-	499,11	496,32	457,0	160,0	70,0	51,0	9,5				
STB144S14M55	144	8B	3020	-	641,71	638,92	600,0	160,0	70,0	51,0	9,5				

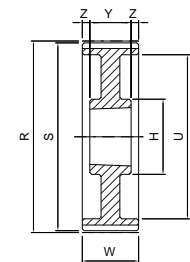

8A

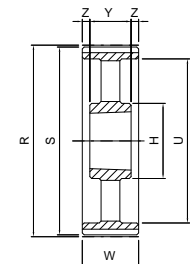

8B

Dimensions of timing pulleys SUPER TORQUE - mounting taper bushing SER-SIT®

STB ... S14M 85

14M



Code	Teeth nr.	Type	SER-SIT® Taper bushing	E [mm]	R [mm]	S [mm]	U [mm]	H [mm]	W [mm]	Y [mm]	Z [mm]	Flange	Material
STB28S14M85	28	5	2517	134,0	124,78	121,98	98,0	-	102,0	45,0	28,5	with flanges	cast iron
STB29S14M85	29	5	2517	134,0	129,23	126,44	100,0	-	102,0	45,0	28,5		
STB30S14M85	30	5	2517	142,0	133,69	130,90	100,0	-	102,0	45,0	28,5		
STB32S14M85	32	5	2517	150,0	142,60	139,81	104,0	-	102,0	45,0	28,5		
STB34S14M85	34	5	2517	158,0	151,51	148,72	110,0	-	102,0	45,0	28,5		
STB36S14M85	36	5	3020	166,0	160,43	157,63	120,0	-	102,0	51,0	25,5		
STB38S14M85	38	5	3020	177,0	169,34	166,55	130,0	-	102,0	51,0	25,5		
STB40S14M85	40	5	3020	186,0	178,25	175,46	138,0	-	102,0	51,0	25,5		
STB44S14M85	44	5	3030	209,0	196,08	193,28	154,0	-	102,0	76,0	13,0		
STB48S14M85	48	5	3030	216,0	213,90	211,11	172,0	-	102,0	76,0	13,0		
STB56S14M85	56	5	3535	261,0	249,56	246,76	207,0	-	102,0	89,0	6,5		
STB64S14M85	64	8	3535	288,0	285,21	282,41	243,0	178,0	102,0	89,0	6,5		
STB72S14M85	72	8A	3535	-	320,86	318,06	279,0	178,0	102,0	89,0	6,5		
STB80S14M85	80	8B	3535	-	356,51	353,71	314,0	178,0	102,0	89,0	6,5		
STB90S14M85	90	8B	3535	-	401,07	398,28	359,0	178,0	102,0	89,0	6,5		
STB112S14M85	112	8B	3535	-	499,11	496,32	457,0	178,0	102,0	89,0	6,5		
STB144S14M85	144	8B	3535	-	641,71	638,92	600,0	178,0	102,0	89,0	6,5		
												without flanges	

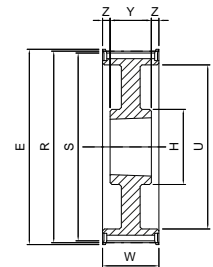
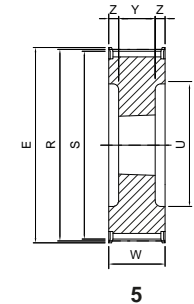

STB ... S14M 115

14M

Code	Teeth nr.	Type	SER-SIT® Taper bushing	E [mm]	R [mm]	S [mm]	U [mm]	H [mm]	W [mm]	Y [mm]	Z [mm]	Flange	Material
STB28S14M115	28	5	2517	134,0	124,78	121,98	98,0	-	133,0	45,0	44,0	with flanges	cast iron
STB29S14M115	29	5	2517	134,0	129,23	126,44	100,0	-	133,0	45,0	44,0		
STB30S14M115	30	5	2517	142,0	133,69	130,90	100,0	-	133,0	45,0	44,0		
STB32S14M115	32	5	2517	150,0	142,60	139,81	104,0	-	133,0	45,0	44,0		
STB34S14M115	34	5	2517	158,0	151,51	148,72	110,0	-	133,0	45,0	44,0		
STB36S14M115	36	5	3020	166,0	160,43	157,63	120,0	-	133,0	51,0	41,0		
STB38S14M115	38	5	3020	177,0	169,34	166,55	130,0	-	133,0	51,0	41,0		
STB40S14M115	40	5	3020	186,0	178,25	175,46	138,0	-	133,0	51,0	41,0		
STB44S14M115	44	5	3030	209,0	196,08	193,28	154,0	-	133,0	76,0	28,5		
STB48S14M115	48	5	3030	216,0	213,90	211,11	172,0	-	133,0	76,0	28,5		
STB56S14M115	56	5	3535	261,0	249,56	246,76	207,0	-	133,0	89,0	22,0		
STB64S14M115	64	8	3535	288,0	285,21	282,41	243,0	178,0	133,0	89,0	22,0		
STB72S14M115	72	8A	3535	-	320,86	318,06	279,0	178,0	133,0	89,0	22,0		
STB80S14M115	80	8B	3535	-	356,51	353,71	314,0	178,0	133,0	89,0	22,0		
STB90S14M115	90	8B	3535	-	401,07	398,28	359,0	178,0	133,0	89,0	22,0		
STB112S14M115	112	8B	3535	-	499,11	496,32	457,0	178,0	133,0	89,0	22,0		
STB144S14M115	144	8B	4040	-	641,71	638,92	600,0	215,0	133,0	102,0	15,5		
												without flanges	

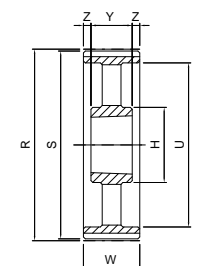
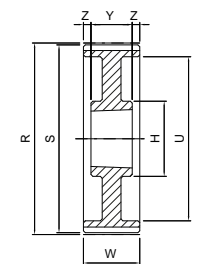

STB ... S14M 170

14M

Code	Teeth nr.	Type	SER-SIT® Taper bushing	E [mm]	R [mm]	S [mm]	U [mm]	H [mm]	W [mm]	Y [mm]	Z [mm]	Flange	Material
STB38S14M170	38	5	3030	177,0	169,34	166,55	130,0	-	187,0	76,0	55,5	with flanges	cast iron
STB40S14M170	40	5	3030	186,0	178,25	175,46	138,0	-	187,0	76,0	55,5		
STB44S14M170	44	5	3535	209,0	196,08	193,28	154,0	-	187,0	89,0	49,0		
STB48S14M170	48	5	3535	216,0	213,90	211,11	172,0	-	187,0	89,0	49,0		
STB56S14M170	56	5	3535	261,0	249,56	246,76	207,0	-	187,0	89,0	49,0		
STB64S14M170	64	5	4040	288,0	285,21	282,41	243,0	-	187,0	102,0	42,5		
STB72S14M170	72	5	4040	-	320,86	318,06	279,0	215,0	187,0	102,0	42,5	without flanges	cast iron
STB80S14M170	80	8A	4040	-	356,51	353,71	314,0	215,0	187,0	102,0	42,5		
STB90S14M170	90	8B	4040	-	401,07	398,28	359,0	215,0	187,0	102,0	42,5		
STB112S14M170	112	8B	5050	-	499,11	496,32	457,0	267,0	187,0	127,0	30,0		
STB144S14M170	144	8B	5050	-	641,71	638,92	600,0	267,0	187,0	127,0	30,0		